

MAKE YOUR CHOICE
TREFFEN SIE IHRE WAHL / FAÏTES VOTRE CHOIX

SHAPES
FORMEN / FORMES

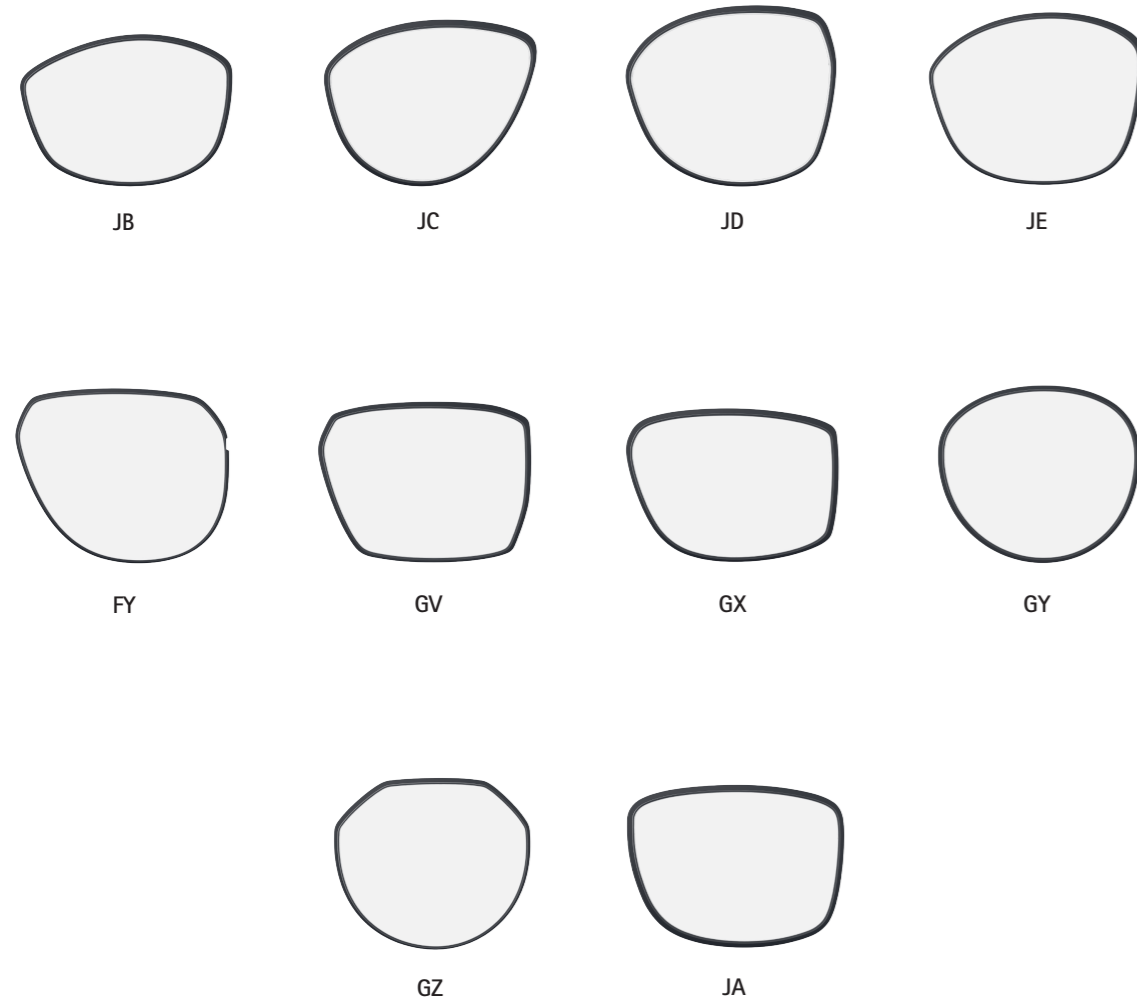

Silhouette
ICONIC EYEWEAR MADE IN AUSTRIA. SINCE 1964.



ACCENT RINGS
CORE CONCEPT

Mod. 5097

Milling of optical lenses with nylon-groove

Groove-depth:	0,70 mm
Groove-width:	0,80 mm
Basis curve frame:	5
Basis curve lens:	4-6
Minimum thickness of lens rim:	1,8 - 2,0 mm

Optische Linse mit Nylon-Nut schleifen

Nuttiefe:	0,70 mm
Nutbreite:	0,80 mm
Basiskurve Fassung:	5
Basiskurve Linse:	4-6
Minimale Glasranddicke:	1,8 - 2,0 mm

Taillage des verres optiques avec rainure nylon

Profondeur de rainure:	0,70 mm
Largeur de rainure:	0,80 mm
Courbure de base de la monture:	5
Courbure de base du verre:	4-6
Verre:	1,8 - 2,0 mm

IN-LINE GLAZING

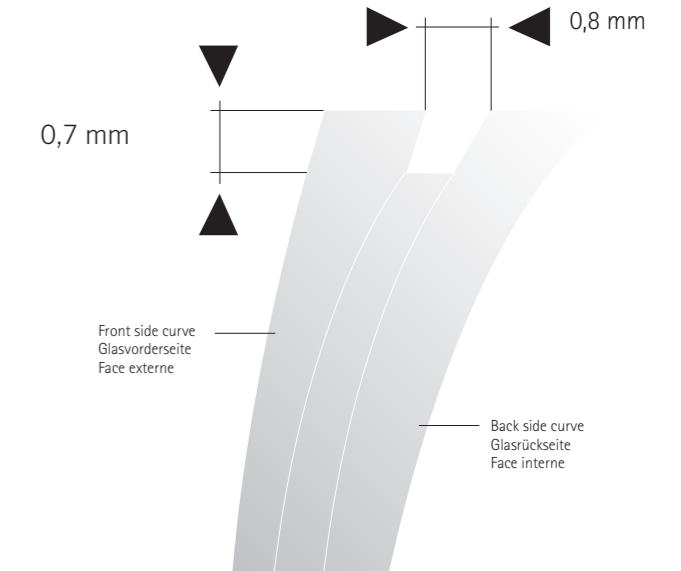

F JB00 52 0000 0000	F GV00 52 0000 0000
F JB00 54 0000 0000	F GV00 54 0000 0000
F JC00 52 0000 0000	F GX00 52 0000 0000
F JC00 54 0000 0000	F GX00 54 0000 0000
F JD00 52 0000 0000	F GY00 49 0000 0000
F JD00 54 0000 0000	F GY00 51 0000 0000
F JE00 53 0000 0000	F GZ00 48 0000 0000
F JE00 55 0000 0000	F GZ00 50 0000 0000
F FY00 53 0000 0000	F JA00 53 0000 0000
F FY00 55 0000 0000	F JA00 55 0000 0000

Accent rings made of SPX®+
Accent Rings aus SPX®+
Accent rings en SPX®+



cardboard box FK 170
cleaning cloth PL 18
cleaning cloth PL 30 (for shape FY)
VH 85 (technical info)



P 0036
universal mounting box
Universal-Montage-Box
boite de montage universelle

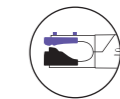

specifications are subject to change without notice, no liability will be assumed for misprints
technische Änderungen und Druckfehler vorbehalten
sous réserve de modifications techniques et d'erreurs d'impression

www.silhouette.com

MAKE YOUR CHOICE
TREFFEN SIE IHRE WAHL / FAÏTES VOTRE CHOIX

COLOUR
FARBE / COULEUR

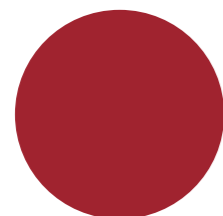

3010
cherry red

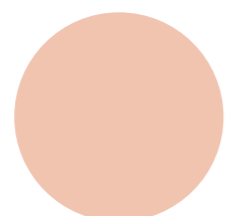

3510
salmon

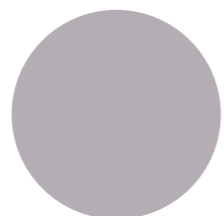

4110
mauve

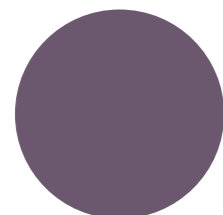

4310
blackberry

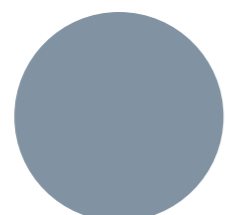

4510
steel blue

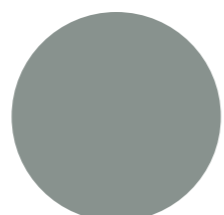

5510
spruce green

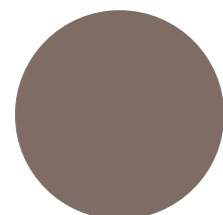

6110
brown

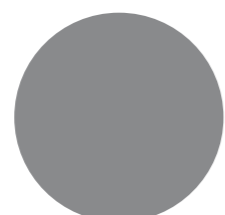

6510
slate grey

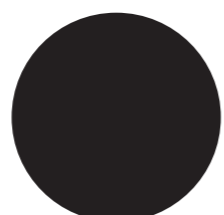

9010
black

Mod.	3010 cherry red	3510 salmon	4110 mauve	4310 blackberry	4510 steel blue	5510 spruce green	6110 brown	6510 slate grey	9010 black
JB 52/54									
JC 52/54									
JD 52/54									
JE 53/55									
GV 52/54									
GX 52/54									
GY 49/51									
GZ 48/50									
FY 53/55									
JA 53/55									

EXAMPLE / BEISPIEL / EXEMPLE: 0 5097 GZ 3010 4800