

Silhouette®

AUTHENTIC EYEWEAR. SINCE 1964.

Mod. 5516



ALPHA



STYLE SHADES / CLIP ON

CHASSIS

GARNITUR / KIT

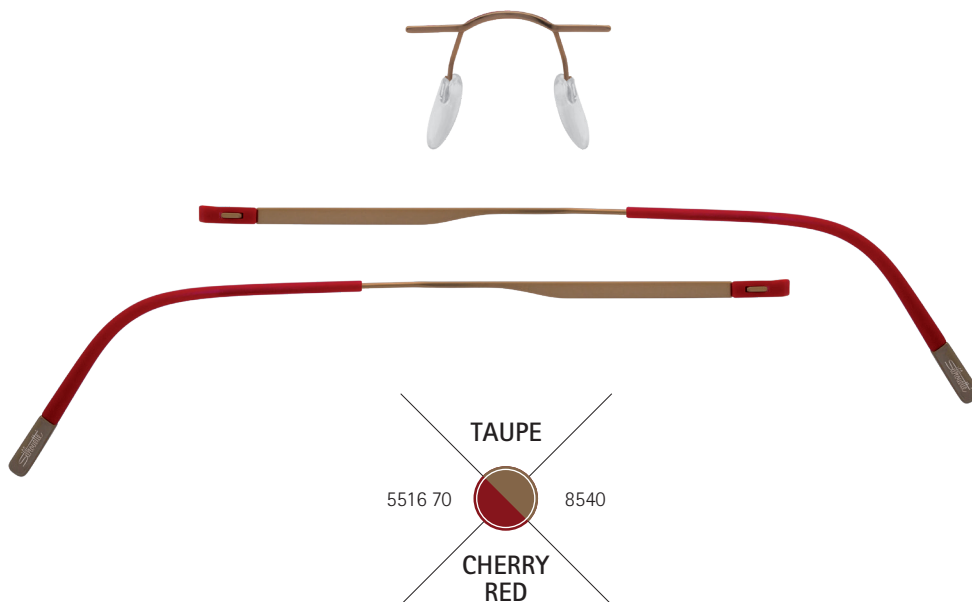

Frame made of High-Tech Titanium with parts of SPX*+
 Brillenfassung aus High-Tech Titan mit Teilen aus SPX*+
 Monture en High-Tech Titan avec parties en SPX*+







17
 19
 21



135 / 140
 140 / 145
 14



NEW - NEU - NOUVEAU

The sensation of perfect vision. PREMIUM LENSES MADE BY SILHOUETTE.
 Die Sensation perfekten Sehens. HOCHWERTIGE GLÄSER AUS DEM HAUSE SILHOUETTE.
 La sensation d'une expérience visuelle parfaitement aboutie. DES VERRES HAUTE DE GAMME PAR SILHOUETTE.

COLOURS

FARBEN / COULEURS

ALPHA / Mod. 5516

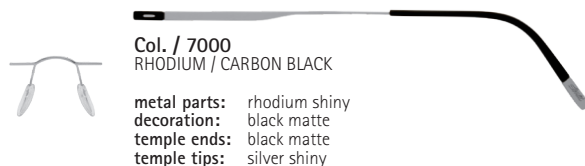
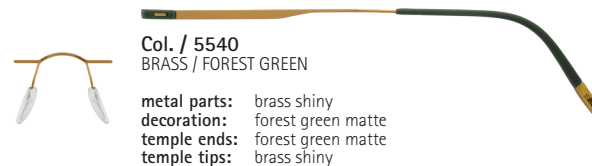

COLOURS

FARBEN / COULEURS

NEW – DOUBLE-DIGIT AND DESCRIPTIVE COLOUR CODE

Each colour group will in future have a double-digit number range, e.g. Transparent 10-14, Red 30-34, etc. Please refer to the colour circle below for details. However, the same number in the colour code does NOT mean the same colour tone.

NEU – 2-STELLIGER UND „SPRECHENDER“ FARBCODE

Künftig hat jede Farbgruppe einen 2-stelligen Zahlenbereich, z.B. Transparent 10-14, Rot 30-34 etc. Details dazu im unten abgebildeten Farbkreis. Gleiche Nummer im Farbcode bedeutet jedoch NICHT gleicher Farbton.

NOUVEAU – CODE COULEUR « PARLANT » À DEUX CHIFFRES

À l'avenir, chaque groupe de couleur portera un code à deux chiffres, par ex. transparent 10-14, rouge 30-34 etc. Plus de détails à ce sujet dans le cercle chromatique dessiné ci-dessous. Les mêmes numéros de code couleur ne signifient cependant PAS que la nuance est la même.

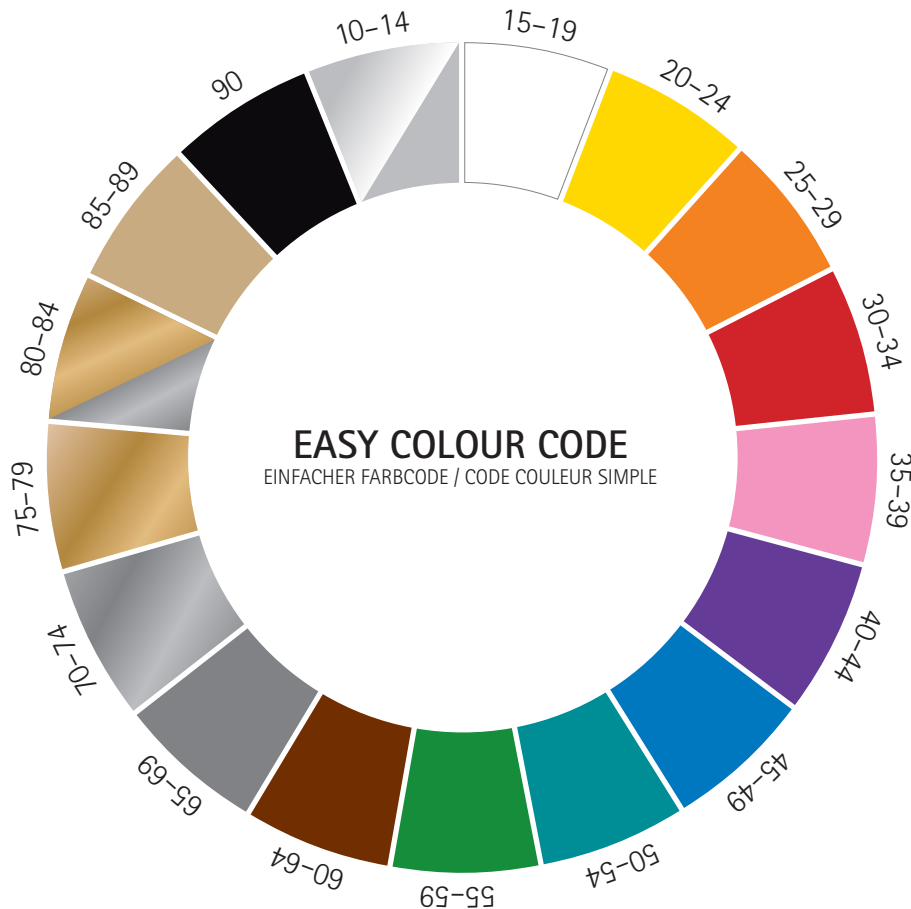

NEW ITEM NUMBERS

NEUE ARTIKELNUMMERN / NOUVEAUX NUMÉROS D'ARTICLE

EXAMPLE: LENS LETTERING
 BEISPIEL GLASBESCHRIFTUNG
 EXEMPLE AVEC LE MARQUAGE DU VERRE

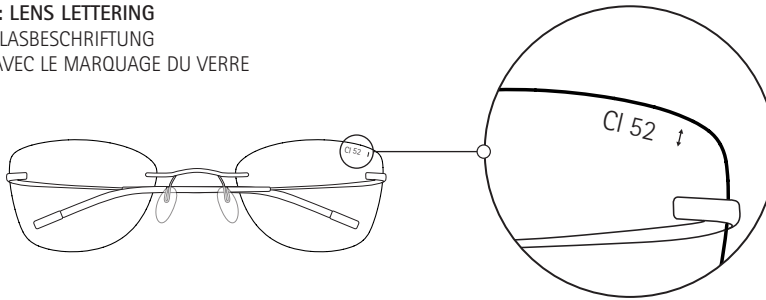

Lens shape-ID
 Scheibenform-ID
 Code de la forme des verres

CI 52 ↑↓

Size
 Größe
 Taille

Different lens sizes available

verschiedene Scheiben-
 größen verfügbar
 différentes tailles de
 verres disponibles

EXAMPLE: DEMO MODEL
 BEISPIEL DEMO-MODELL
 EXEMPLE MODÈLE DE DÉMO



Model
 Modell
 Modèle

Colour code/Surface
 Farbcode/Oberfläche
 Code couleur/surface

Temple length
 Bügellänge
 Longueur des branches

5516 CI 7100 52 □ 17 140

Lens shape-ID
 Scheibenform-ID
 Code de la forme des verres

Size
 Größe
 Taille



EXAMPLE: CHASSIS
 BEISPIEL GARNITUR
 EXEMPLE DE KIT

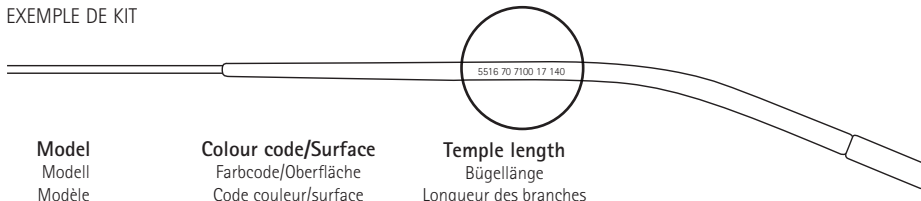

Model
 Modell
 Modèle

Colour code/Surface
 Farbcode/Oberfläche
 Code couleur/surface

Temple length
 Bügellänge
 Longueur des branches

5516 70 7100 17 140

Chassis
 Garnitur
 Kit

Bridge size
 Steggröße
 Taille de pont

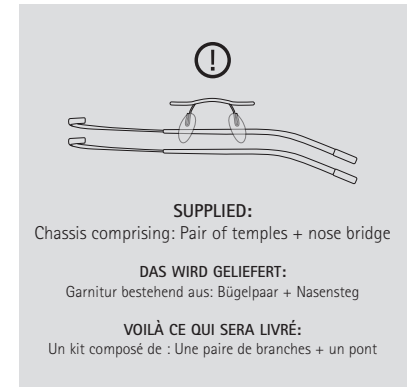

SHAPES

SCHEIBENFORMEN / FORME



RHODIUM / HOT PINK
MOD. 5516/CI-7100

 x 			
52 x 44 (18,14 cm ²)	57	17	140
54 x 46 (19,56 cm ²)	60	17	140



ROSE GOLD / SALMON
MOD. 5516/CW-3530

 x 			
52 x 36 (15,14 cm ²)	56	17	135
54 x 37 (16,33 cm ²)	58	17	135



GOLD / COOL MINT
MOD. 5516/ES*-7635

* with demo lenses mint gradient 25-0%

 x 			
51 x 44 (16,64 cm ²)	54	17	135
53 x 45 (17,97 cm ²)	57	17	135



BLACKBERRY / LILAC
MOD. 5516/ET-4040

 x 			
53 x 41 (16,92 cm ²)	57	17	140
55 x 42 (18,22 cm ²)	59	17	140



TAUPE / CHERRY RED
MOD. 5516/EU-8540

			
51 x 41 (16,41 cm ²)	55	19	140
53 x 42 (17,72 cm ²)	57	19	140



GOLD / BLACK
MOD. 5516/DF-7530

			
52 x 39 (17,72 cm ²)	60	19	145
54 x 40 (19,11 cm ²)	63	19	145



PURE BLACK
MOD. 5516/DV-9040

			
51 x 33 (14,65 cm ²)	57	17	140
53 x 60 (15,82 cm ²)	60	17	140



RUTHEINUM / SPACE BLUE
MOD. 5516/EL**-6565

			
54 x 47 (20,12 cm ²)	63	17	145
56 x 48 (21,64 cm ²)	65	17	145

Shape EL: please order **MST 946-1** (upper bridge) incl. **BLS 44** with **MST 965** and **SP 107** (nose pads - instead of SP 96)

Bei Shape EL: Bitte bestellen Sie **MST 946-1** inkl. **BLS 44** mit **MST 965** und **SP 107** (Nasenpads statt SP 96)

Pour la forme EL: Veuillez commander la pièce **MST 946-1** (pont supérieur) incluant les **BLS 44** en même temps que les pièces **MST 965** et **SP 107** (plaquettes - en lieu et place de la référence SP 96)







RHODIUM / CARBON BLACK
MOD. 5516/EN-7000

			
52 x 36 (16,29 cm ²)	57	19	145
54 x 38 (17,56 cm ²)	59	19	145



BRASS / FOREST GREEN
MOD. 5516/EO-5540

			
52 x 43 (18,39 cm ²)	62	17	140
54 x 45 (19,83 cm ²)	64	17	140







SIMPLY BROWN
MOD. 5516/EP-6040

			
46 x 42 (15,09 cm ²)	49	21	140
48 x 43 (16,43 cm ²)	51	21	140



NAVY BLUE / SLATE
MOD. 5516/EQ***-4545

			
51 x 41 (17,42 cm ²)	56	19	145
53 x 43 (18,81 cm ²)	59	19	145

***with demo lenses blue gradient 25-0%

ORDER CHASSIS

BESTELLUNG GARNITUR / COMMANDE KIT
Sortiment / Assortment / Assortiment

ALPHA / Mod. 5516

Mod.	Größe, Size Taille	Größe, Size Taille												Chassis, Garnitur, Kit	Größe, Size Taille		
		3530	4040	4540	5540	6040	6560	7000	7100	7530	7630	8540	9040				
5516/CI	52/17 54/17															5516 70	17/140
5516/CW	52/17 54/17															5516 70	17/135
5516/ES*	51/17 53/17															5516 70	17/135
5516/ET	53/17 55/17															5516 70	17/140
5516/EU	51/19 53/19															5516 70	19/140
5516/DF	52/19 54/19															5516 70	19/145
5516/DV	51/17 53/17															5516 70	17/140
5516/EL*	54/17 56/17															5516 70	17/145
5516/EN	52/19 54/19															5516 70	19/145
5516/EO	52/17 54/17															5516 70	17/140
5516/EP	46/20** 48/20**															5516 70	21/140
5516/EQ*	51/19 53/19															5516 70	19/145

entsprechende Version der Garnitur / equivalent version of the chassis / référence du kit correspondant

* Shapes EL, ES, EQ with tinted demo lenses

** bridge size is 21

Chassis 5516 / 70: 17/35, 17/40, 17/45, 19/40, 19/45, 21/40



Glazed models are only available in one colour and in one size (see above schema).
Verglaste Modelle sind jeweils nur in einer Farbe und in einer Größe erhältlich (siehe Tabelle oben).
Les montures percées ne sont disponible qu'en une couleur et en une taille (voir tableau ci-dessus).

ALPHA / Mod. 5516



CLIP-ON 5095

available in 2 colours / erhältlich in 2 Farben / disponible en 2 couleurs



5095/00 grey/green



5095/05 brown



0 5095 00 00CI
52/17, 54/17



0 5095 00 00CW
52/17, 54/17



0 5095 00 00DF
52/19, 54/19



0 5095 00 00DV
51/17, 53/17



0 5095 00 00EL
54/17, 56/17



0 5095 00 00EN
52/19, 54/19



0 5095 00 00EO
52/19, 54/19



0 5095 00 00EP
46/21, 48/21



0 5095 00 00EQ
51/19, 53/19



0 5095 00 00ES
51/17, 53/17



0 5095 00 00ET
53/17, 55/17



0 5095 00 00EU
51/19, 53/19



STYLE SHADES

STYLE SHADES 5090

available in 3 colours / disponible en 3 couleurs

ALPHA / Mod. 5516

STYLE SHADES 5090 A3

lens colour / Glasfarbe / couleur des verres:
grey with silver flash-mirror / grau mit Silber-Flash / gris avec miroir argenté

bridge colour / Stegfarbe / couleur du pont:
grey silky-matte / grau seidenmatt / gris mat soyeux



0 5090 A3 0101
59/15 S, 62/15 L



0 5090 A3 0301
59/15 S, 62/15 L



0 5090 A3 0701
62/15 S, 64/15 L



0 5090 A3 0601
62/15 S, 64/15 L



0 5090 A3 0801
56/15 S, 58/15 L

STYLE SHADES 5090 B3

lens colour / Glasfarbe / couleur des verres:
brown with bronze flash-mirror / braun mit bronze Flash-Spiegel / brun avec miroir bronze

bridge colour / Stegfarbe / couleur du pont:
bronze silky-matte / bronze seidenmatt / bronze mat soyeux

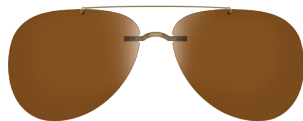

0 5090 B3 0102
59/15 S, 62/15 L



0 5090 B3 0302
59/15 S, 62/15 L



0 5090 B3 0702
62/15 S, 64/15 L



0 5090 B3 0602
62/15 S, 64/15 L



0 5090 B3 0802
56/15 S, 58/15 L

STYLE SHADES 5090 A3

lens colour / Glasfarbe / couleur des verres:
blue with silver flash mirror / blau mit Silberflash / bleu avec miroir silver

bridge colour / Stegfarbe / couleur du pont:
grey silky-matte / grau seidenmatt / gris mat soyeux



0 5090 A3 0103
59/15 S, 62/15 L



0 5090 A3 0303
59/15 S, 62/15 L



0 5090 A3 0703
62/15 S, 64/15 L



0 5090 A3 0603
62/15 S, 64/15 L



0 5090 A3 0803
56/15 S, 58/15 L

STYLE SHADES 5090 A3, STYLE SHADES 5090 B3, STYLE SHADES 5090 A3

to fit models with bridge MST 965
passend für Modelle mit Steg MST 965
approprié aux modèles avec pont MST 965



MST 965

W SH00 10 0015 0065
Display Style Shades
(without content and without motive)



SPARE PARTS

ERSATZTEILE / PIÈCES DE RECHANGE

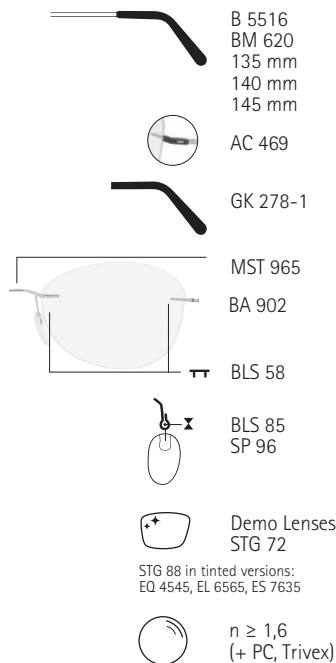

F C100 52 0000 0000	F E000 52 0000 0000
F C100 54 0000 0000	F E000 54 0000 0000
F CW00 52 0000 0000	F EP00 46 0000 0000
F CW00 54 0000 0000	F EP00 48 0000 0000
F DF00 52 0000 0000	F EQ00 51 0000 0000
F DF00 54 0000 0000	F EQ00 53 0000 0000
F DV00 51 0000 0000	F ES00 51 0000 0000
F DV00 53 0000 0000	F ES00 53 0000 0000
F EL00 54 0000 0000	F ET00 53 0000 0000
F EL00 56 0000 0000	F ET00 55 0000 0000
F EN00 52 0000 0000	F EU00 51 0000 0000
F EN00 54 0000 0000	F EU00 53 0000 0000

We recommend base curve 5, other curves possible
Wir empfehlen Basiskurve 5, andere Basiskurven möglich
Nous recommandons base 5, autres courbes possible



SHE 153-2



P 0033
universal mounting-box
Universal-Montage-Box
boîte de montage universelle

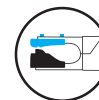

P 0031
pliers box
Zangen-Box
boîte pour pinces



Cleaning cloth PL 18
Cardboard Box FK 104-3

Shape EL:

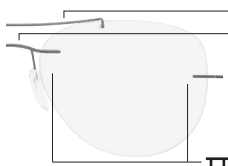

MST 946-1 incl. BLS 44
MST 965

BA 902

BLS 58



BLS 85
SP 107



P 0031
Zangen-Box
pliers box
boîte pour pinces

Shape EL:
please order MST 946-1 (upper bridge) incl. BLS 44 together with
MST 965 and SP 107 (nose pads – instead of SP 96)

Bei Shape EL:
Bitte bestellen Sie MST 946-1 inkl. BLS 44 mit MST 965 und SP 107
(Nasenpads statt SP 96)

Pour la forme EL:
Veuillez commander la pièce MST 946-1 (pont supérieur)
incluant les BLS 44 en même temps que les pièces MST 965 et
SP 107 (plaquettes – en lieu et place de la référence SP 96)

METAL PARTS SURFACE / OBERFLÄCHEN METALLTEILE / SURFACES METALLIQUES

Mod. 5516

Frame made of High-Tech Titanium
with parts of SPX®+

Brillenfassung aus High-Tech Titan
mit Teilen aus SPX®+

Monture en High-Tech Titan
avec parties en SPX®+

Col. 7000, 7100
rhodium plated, with lacquer finish
rhodiniert, mit Lackfinish
rhodié, avec finition vernie

Col. 3630, 7530, 7630
gold plated with lacquer finish
vergoldet, mit Lackfinish
plaqué-or, avec finition vernie

Col. 4040, 4540, 5540, 6040, 8540, 9040
with colour- and lacquer-finish
mit Farbfinish und Lackbeschichtung
avec couleur de finition vernie

Col. 6560
ruthenium plated, with lacquer finish
mit Ruthenium beschichtet, mit Lackfinish
plaqué en ruthenium, avec finition vernie

specifications are subject to change without notice, no liability will be assumed for misprints
technische Änderungen und Druckfehler vorbehalten
sous réserve de modifications techniques et d'erreurs d'impression