

Silhouette®

ICONIC EYEWEAR MADE IN AUSTRIA. SINCE 1964.

Mod. 5518



TITAN MINIMAL ART
THE ICON. ACCENT RINGS

CHASSIS

GARNITUR / KIT



Frame made of High-Tech Titanium with parts of SPX®+
 Brillenfassung aus High-Tech Titan mit Teilen aus SPX®+
 Monture en High-Tech Titan avec parties en SPX®+

Chassis without accent ring 5097 - please order separately.
 Garnitur ohne accent ring 5097 - bitte separat bestellen.
 Chassis sans accent ring 5097 - à commander séparément.







17
 19
 21



140/145/150
 140/145/150
 150/160

COLOURS

FARBEN / COULEURS

TMA THE ICON. ACCENT RINGS / Mod. 5518



Col. / 3530
ROSE GOLD / AMETHYST

metal parts: rose gold silky matte
temple ends: amethyst
decoration ring: rose gold silky matte
temple tips: amethyst matte

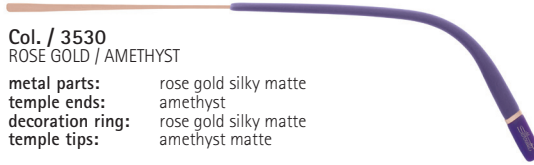

Col. / 5540
BRASS / LIGHT TEAL

metal parts: brass silky matte
temple ends: light teal
decoration ring: brass silky matte
temple tips: light teal matte

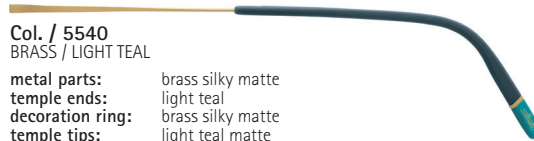

Col. / 7010
COOL GREY / SALMON

metal parts: titanium shiny
temple ends: grey
decoration ring: titanium shiny
temple tips: salmon matte

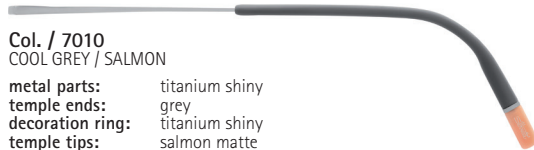

Col. / 7110
COOL GREY / CRYSTAL

metal parts: titanium silky matte
temple ends: grey
decoration ring: titanium silky matte
temple tips: grey matte

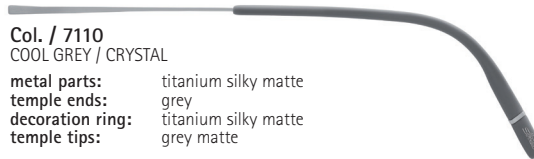

Col. / 7200
RHODIUM / DENIM BLUE

metal parts: rhodium silky matte
temple ends: denim blue
decoration: rhodium silky matte
temple tips: denim blue matte

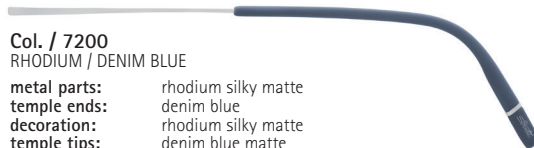

Col. / 7530
GOLD / BLACK

metal parts: gold shiny
temple ends: black
decoration ring: gold shiny
temple tips: black matte

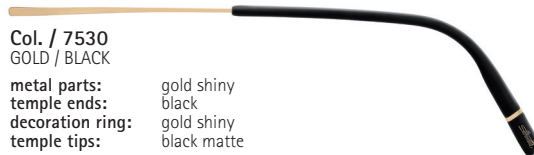

COLOURS

FARBEN / COULEURS

NEW – DOUBLE-DIGIT AND DESCRIPTIVE COLOUR CODE

Each colour group will in future have a double-digit number range, e.g. Transparent 10-14, Red 30-34, etc. Please refer to the colour circle below for details. However, the same number in the colour code does NOT mean the same colour tone.

NEU – 2-STELLIGER UND „SPRECHENDER“ FARBCODE

Künftig hat jede Farbgruppe einen 2-stelligen Zahlenbereich, z.B. Transparent 10-14, Rot 30-34 etc. Details dazu im unten abgebildeten Farbkreis. Gleiche Nummer im Farbcode bedeutet jedoch NICHT gleicher Farbton.

NOUVEAU – CODE COULEUR « PARLANT » À DEUX CHIFFRES

À l'avenir, chaque groupe de couleur portera un code à deux chiffres, par ex. transparent 10-14, rouge 30-34 etc. Plus de détails à ce sujet dans le cercle chromatique dessiné ci-dessous. Les mêmes numéros de code couleur ne signifient cependant PAS que la nuance est la même.

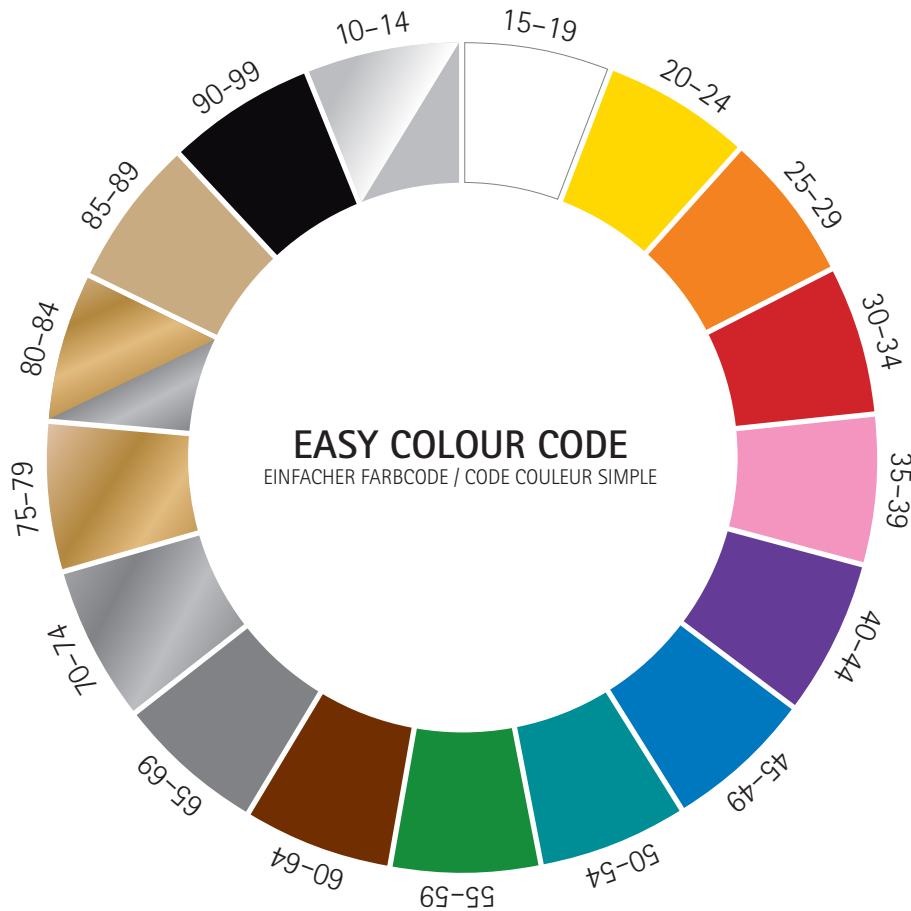

NEW ITEM NUMBERS

NEUE ARTIKELNUMMERN / NOUVEAUX NUMÉROS D'ARTICLE

EXAMPLE: LENS LETTERING
 BEISPIEL GLASBESCHRIFTUNG
 EXEMPLE AVEC LE MARQUAGE DU VERRE

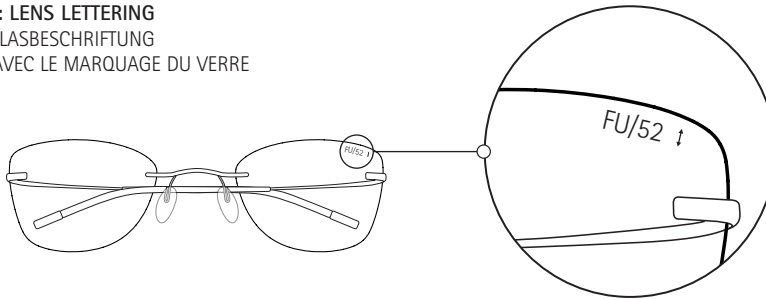

Lens shape-ID
 Scheibenform-ID
 Code de la forme des verres

FU 52 ↕

Size
 Größe
 Taille

Different lens sizes available

verschiedene Scheiben-
 größen verfügbar
 différentes tailles de
 verres disponibles

EXAMPLE: DEMO MODEL
 BEISPIEL DEMO-MODELL
 EXEMPLE MODÈLE DE DÉMO

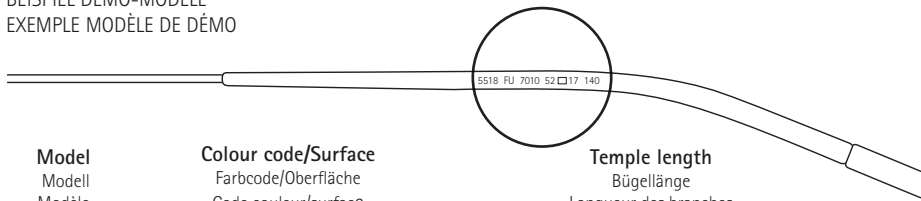

Model
 Modell
 Modèle

Colour code/Surface
 Farbcode/Oberfläche
 Code couleur/surface

Temple length
 Bügellänge
 Longueur des branches

5518 FU 7010 52 □ 17 140

Lens shape-ID
 Scheibenform-ID
 Code de la forme des verres

Size
 Größe
 Taille



EXAMPLE: CHASSIS
 BEISPIEL GARNITUR
 EXEMPLE DE KIT

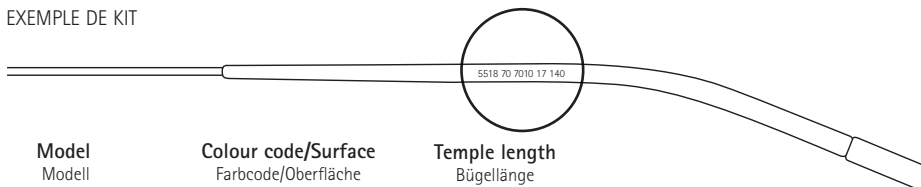

Model
 Modell
 Modèle

Colour code/Surface
 Farbcode/Oberfläche
 Code couleur/surface

Temple length
 Bügellänge
 Longueur des branches

5518 70 7010 17 140

Chassis
 Garnitur
 Kit

Bridge size
 Steggröße
 Taille de pont

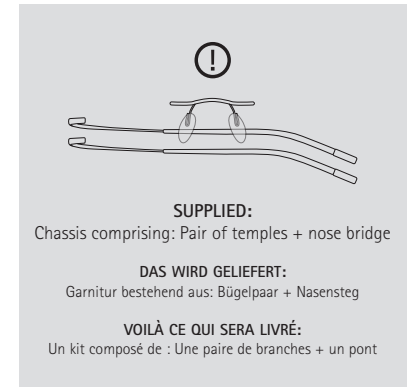





SHAPES

SCHEIBENFORMEN / FORME







BRASS / LIGHT TEAL
MOD. 5518/FT-5540

			
54 x 40 (17,63 cm ²)	60	17	145
56 x 42 (18,96 cm ²)	62	17	145







COOL GREY / SALMON
MOD. 5518/FU-7010

			
52 x 41 (15,73 cm ²)	57	17	140
54 x 42 (16,97 cm ²)	59	17	140



ROSE GOLD / AMETHYST
MOD. 5518/FW-3530

			
53 x 40 (16,22 cm ²)	57	17	140
55 x 41 (17,47 cm ²)	59	17	140







COOL GREY / CRYSTAL
MOD. 5518/FV-7110

			
50 x 44 (17,57 cm ²)	53	19	145
52 x 46 (19,01 cm ²)	55	19	145







RHODIUM / DENIM BLUE
MOD. 5518/FY-7200

			
53 x 44 (18,76 cm ²)	60	17	145
55 x 45 (20,21 cm ²)	62	17	145









GOLD / BLACK
MOD. 5518/FZ-7530

			
50 x 39 (15,33 cm ²)	52	19	140
52 x 40 (16,58 cm ²)	54	19	140

ORDER CHASSIS

BESTELLUNG GARNITUR / COMMANDE KIT
Sortiment / Assortment / Assortiment

entsprechende Version der Garnitur / equivalent version of the chassis / référence du kit correspondant

Mod.	Größe, Size Taille	3530	5540	7010	7110	7200	7530	Chassis, Garnitur, Kit	Größe, Size Taille
5518/FT	54/17 56/17							5518 70	17/145
5518/FU	52/17 54/17							5518 70	17/140
5518/FV	50/18* 52/18*							5518 70	19/145
5518/FW	53/17 55/17							5518 70	17/140
5518/FY	53/17 55/17							5518 70	17/145
5518/FZ	50/19 52/19							5518 70	19/140

* bridge size is 19

Chassis 5518 / 70: 17/40, 17/45, 17/50
19/40, 19/45, 19/50
21/50, 21/60

Chassis without accent ring 5097 - please order separately.
Garnitur ohne accent ring 5097 - bitte separat bestellen.
Chassis sans accent ring 5097 - à commander séparément.



Glazed models are only available in one colour and in one size (see above schema).
Verglaste Modelle sind jeweils nur in einer Farbe und in einer Größe erhältlich (siehe Tabelle oben).
Les montures percées ne sont disponibles qu'en une couleur et en une taille (voir tableau ci-dessus).

IN-LINE GLAZING

Milling of optical lenses with nylon-groove

Groove-depth:	0,60 mm
Groove-width:	0,80 mm
Basis curve frame:	5
Basis curve lens:	4-6
Minimum thickness of lens rim:	1,8 - 2,0 mm

Optische Linse mit Nylon-Nut schleifen

Nuttiefe:	0,60 mm
Nutbreite:	0,80 mm
Basiskurve Fassung:	5
Basiskurve Linse:	4-6
Minimale Glasranddicke:	1,8 - 2,0 mm

Taillage des verres optiques avec rainure nylon

Profondeur de rainure:	0,60 mm
Largeur de rainure:	0,80 mm
Courbure de base de la monture:	5
Courbure de base du verre:	4-6
Verre:	1,8 - 2,0 mm

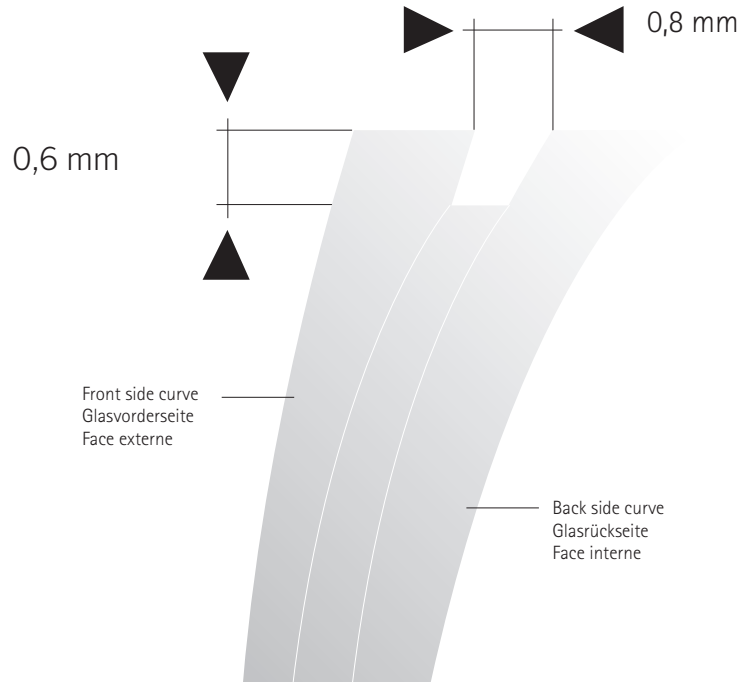

SPARE PARTS

ERSATZTEILE / PIÈCES DE RECHANGE

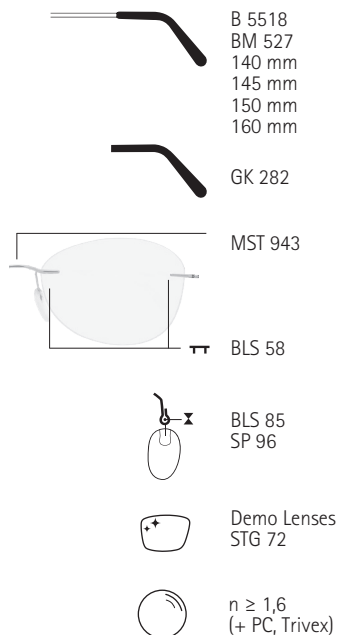

F FT00 54 0000 0000
F FT00 56 0000 0000

F FU00 52 0000 0000
F FU00 54 0000 0000

F FW00 53 0000 0000
F FW00 55 0000 0000

F FV00 50 0000 0000
F FV00 52 0000 0000

F FY00 53 0000 0000
F FY00 55 0000 0000

F FZ00 50 0000 0000
F FZ00 52 0000 0000

We recommend base curve 5, other curves possible
Wir empfehlen Basiskurve 5, andere Basiskurven möglich
Nous recommandons base 5, autres courbes possible



SHE 195



P 0033
Universal-Montage-Box
universal mounting-box
boite de montage universelle



P 0031
Zangen-Box
pliers box
boite pour pinces



Cleaning cloth PL 30
Demo: Cardboard Box FK 113-3

VH 85

MH (rubber ring)
only for shape FV

METAL PARTS SURFACE / OBERFLÄCHEN METALLTEILE / SURFACES METALLIQUES

Mod. 5518

Metal frame made of High Tech Titanium
with parts made of SPX®+

Metallfassung aus High Tech Titan
mit Teilen aus SPX®+

Monture en métal fabriqués en
High Tech Titanium avec parties en SPX®+

Col. 7200

rhodium plated, with lacquer finish
rhodiniert, mit Lackfinish
rhodié, avec finition vernie

Col. 7010, 7110

titanium plated, with lacquer finish
mit Titan beschichtet, mit Lackfinish
plaqué en titane, avec finition vernie

Col. 3530, 7530

gold plated, with lacquer finish
vergoldet, mit Lackfinish
plaqué-or, avec finition vernie

Col. 5540

with color- and lacquer-finish
mit Farbfinish und Lackbeschichtung
avec couleur de finition vernie



NEW - NEU - NOUVEAU

The sensation of perfect vision. PREMIUM LENSES MADE BY SILHOUETTE.

Die Sensation perfekten Sehens. HOCHWERTIGE GLÄSER AUS DEM HAUSE SILHOUETTE.

La sensation d'une expérience visuelle parfaitement aboutie. DES VERRES HAUTE DE GAMME PAR SILHOUETTE.

specifications are subject to change without notice, no liability will be assumed for misprints
technische Änderungen und Druckfehler vorbehalten
sous réserve de modifications techniques et d'erreurs d'impression

www.silhouette.com