



LITE ARCS

Try it. Wear it. Love it.

*Silhouette*

ICONIC EYEWEAR MADE IN AUSTRIA. SINCE 1964.

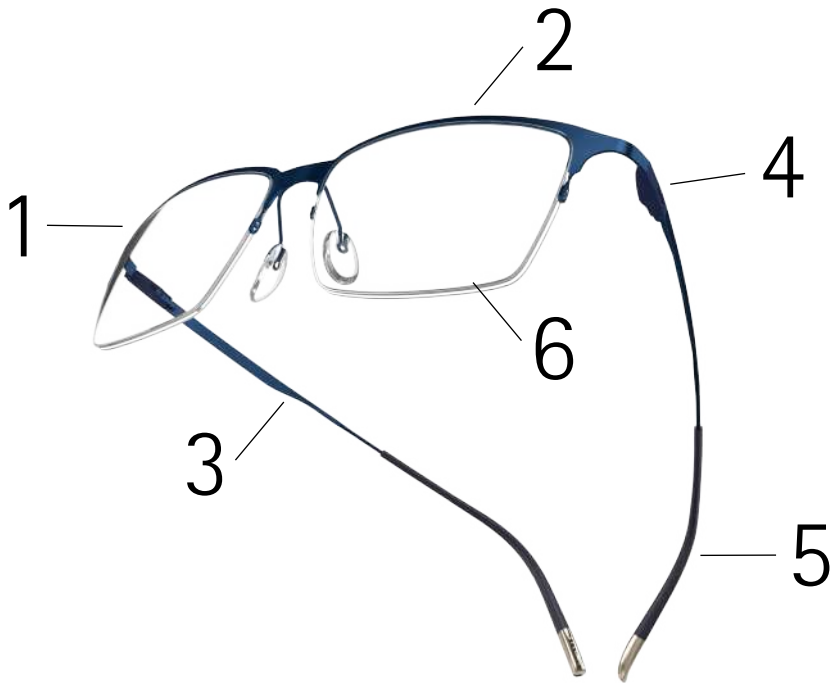

1

A contemporary interpretation of a nylon design with an ultrathin titanium veneer and precision laser finished details  
超薄钛金属板, 高精度激光制作, 符合时代潮流的对半框设计的诠释

---

2

Finely proportioned temples which transition seamlessly from a smoothly even shape into elegantly curved wire temple tips  
精致的镜腿比例, 从扁平的镜腿到圆形金属丝的顺滑过渡

---

3

Molded flex zone in the titanium temple for absolute comfort  
钛金属镜腿具有弹性区域, 提供绝对舒适的佩戴体验

---

4

Maintenance-free hook hinges for easy handling  
免维护的按压式铰链 让操作更简单便捷

---

5

Adjustable and trimmable temples for the perfect fit  
可调节和缩短镜腿打造完美贴合感

---

6

Classic nylon glazing  
经典半框镜片装配



LITE ARCS

Mod. / 型号 5548

Try it. Wear it. Love it.

*Silhouette*

ICONIC EYEWEAR MADE IN AUSTRIA. SINCE 1964.

## COLOURS / 颜色



### Col. / 款型 75 6560 TECH GREY

**Front:** ruthenium silky matte  
**Temples:** ruthenium silky matte  
**Decoration:** grey matte  
**Temple ends:** grey matte  
**Temple tips:** titanium matte

**面框:** 丝质哑光钉色  
**镜腿:** 丝质哑光钉色  
**装饰:** 哑光灰色  
**镜腿脚套:** 哑光灰色  
**镜腿盖帽:** 哑光钛金属色

---



### Col. / 款型 75 7530 DUSTY GOLD

**Front:** gold silky matte  
**Temples:** gold silky matte  
**Decoration:** black matte  
**Temple ends:** black matte  
**Temple tips:** gold matte

**面框:** 丝质哑光金色  
**镜腿:** 丝质哑光金色  
**装饰:** 哑光黑色  
**镜腿脚套:** 哑光黑色  
**镜腿盖帽:** 哑光金色

---



### Col. / 款型 75 9040 PURE BLACK

**Front:** black silky matte  
**Temples:** black silky matte  
**Decoration:** black matte  
**Temple ends:** black matte  
**Temple tips:** black shiny

**面框:** 丝质哑光黑色  
**镜腿:** 丝质哑光黑色  
**装饰:** 哑光黑色  
**镜腿脚套:** 哑光黑色  
**镜腿盖帽:** 亮光黑色

## GROOVED GLAZING / 镜片开槽

Milling of optical lenses with full-rim-groove  
全框镜片开槽

Groove-depth / 槽深 :	0,6 mm
Groove-width / 槽宽 :	0,5 mm
Basis curve frame / 镜框基弯 :	5
Basis curve lens / 镜片基弯 :	3-6
Minimum thickness of lens rim / 镜片边缘最小厚度 :	1,8 - 2,0 mm

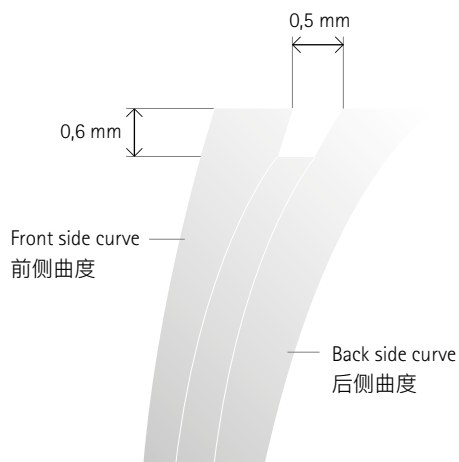

  
54 x 37 (16,99 cm<sup>2</sup>)

  
59

  
16

  
140

## SPARE PARTS / 备件

  
B 5548  
BM 620-1  
140 mm

  
GK 278-1

  
BLS 85  
SP 96

  
NY 2  
lower nylon thread  
尼龙梭心线

  
former STG 70-FS

  
Demo Lenses / 展示镜片  
STG 72

We recommend base curve 5, other curves possible  
我们建议采用5基弯,  
当然也可采用其他曲度

## EQUIPMENT / 设备

  
P 0036  
universal mounting-box  
通用工具箱

  
Case SHE 246  
Cleaning cloth / 清洁布 PL 37  
Cardboard box / 纸板盒 FK  
104-3  
Sticker / 商标贴纸 ET 156-2  
Glazing Tool / 镜片的镶嵌工具  
VGLH 3

  
 $n \geq 1,6$   
(+ PC, Trivex)

## METAL PARTS SURFACE / 金属件表面

Col. / 款型 75 9040  
with colour- and lacquer finish  
彩色, 漆面

Col. / 款型 75 6560  
ruthenium plated, with lacquer finish  
镀钌, 漆面

Col. / 款型 75 7530  
gold plated, with lacquer finish  
镀金, 漆面

## MATERIAL / 材料

Frame made of High-Tech Titanium  
with parts of SPX®+  
镜架采用 SPX®+ 和高科技钛金属构成



LITE ARCS

Mod. / 型号 5549

Try it. Wear it. Love it.

*Silhouette*

ICONIC EYEWEAR MADE IN AUSTRIA. SINCE 1964.

# COLOURS

FARBEN / COULEURS



## Col. / 款型 75 6560 TECH GREY

**Front:** ruthenium silky matte  
**Temples:** ruthenium silky matte  
**Decoration:** grey matte  
**Temple ends:** grey matte  
**Temple tips:** titanium matte

**面框:** 丝质哑光钌色  
**镜腿:** 丝质哑光钌色  
**装饰:** 哑光灰色  
**镜腿脚套:** 哑光灰色  
**镜腿盖帽:** 哑光钛金属色

---



## Col. / 款型 75 7530 DUSTY GOLD

**Front:** gold silky matte  
**Temples:** gold silky matte  
**Decoration:** black matte  
**Temple ends:** black matte  
**Temple tips:** gold matte

**面框:** 丝质哑光金色  
**镜腿:** 丝质哑光金色  
**装饰:** 哑光黑色  
**镜腿脚套:** 哑光黑色  
**镜腿盖帽:** 哑光金色

---



## Col. / 款型 75 9040 PURE BLACK

**Front:** black silky matte  
**Temples:** black silky matte  
**Decoration:** black matte  
**Temple ends:** black matte  
**Temple tips:** black shiny

**面框:** 丝质哑光黑色  
**镜腿:** 丝质哑光黑色  
**装饰:** 哑光黑色  
**镜腿脚套:** 哑光黑色  
**镜腿盖帽:** 亮光黑色



## GROOVED GLAZING / 镜片开槽

Milling of optical lenses with full-rim-groove  
全框镜片开槽

Groove-depth / 槽深 :	0,6 mm
Groove-width / 槽宽 :	0,5 mm
Basis curve frame / 镜框基弯 :	5
Basis curve lens / 镜片基弯 :	3-6
Minimum thickness of lens rim / 镜片边缘最小厚度 :	1,8 - 2,0 mm

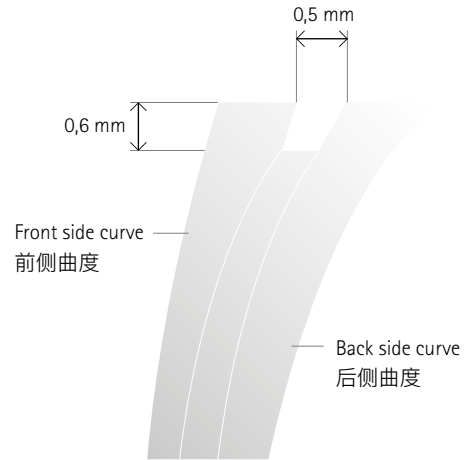

  $54 \times 41$  (18,79 cm<sup>2</sup>)

 61

 16

 140

## SPARE PARTS / 备件

 B 5549  
BM 620-1  
140 mm

 GK 278-1

 BLS 85  
SP 96

 NY 2  
lower nylon thread  
尼龙梭心线

 former STG 70-FS

 Demo Lenses / 展示镜片  
STG 72

We recommend base curve 5, other curves possible  
我们建议采用5基弯,  
当然也可采用其他曲度

## EQUIPMENT / 设备

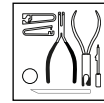

P 0036  
universal mounting-box  
通用工具箱



Case SHE 246  
Cleaning cloth / 清洁布 PL 37  
Cardboard box / 纸板盒 FK  
104-3

Sticker / 商标贴纸 ET 156-2  
Glazing Tool / 镜片的镶嵌工具  
VGLH 3



$n \geq 1,6$   
(+ PC, Trivex)

## METAL PARTS SURFACE / 金属件表面

Col. / 款型 75 9040  
with colour- and lacquer finish  
彩色, 漆面

Col. / 款型 75 6560  
ruthenium plated, with lacquer finish  
镀钌, 漆面

Col. / 款型 75 7530  
gold plated, with lacquer finish  
镀金, 漆面

## MATERIAL / 材料

Frame made of High-Tech Titanium  
with parts of SPX®+  
镜架采用 SPX®+ 和高科技钛金属构成